VDI 2230-1:2014

Mistakes, Comments, Improvement Suggestions

by Fritz Ruoss
HEXAGON Industriesoftware GmbH
Fritz.Ruoss@hexagon.de

Pg. 11: I, IB, Ibers, IBT ..

Translation error: Flächenträgheitsmoment = area moment of inertia (not moment of gyration)

Pg. 35 (R8/1):

Cit.: $FS_{max} = FM_{zul} + \phi_{en} * FA_{max} - \Delta FV_{th}$

Better: $FS_{max} = \max(FM_{zul}, FV_{max} + FS_{Amax} - \Delta FV_{th})$

Maximum load in operational mode is $FS_{max} = FV_{max} + FS_{Amax} - \Delta FV_{th}$

Maximum load in assembly mode is $FS_{max} = FM_{zul}$.

Pg. 36 (R9/1):

Stress area of Sigma a is A0 instead of AS (at least for necked-down bolts and hollow bolts).

Pg. 36 (R9):

False: Calculation of SigmaSab to Equation (214)

Correct: Calculation of SigmaSab to Equation (186)

Pg. 37 (R10/3): $p_{max} = FMT_{ab}/A_{pmin} * 1.4$

Equation (R10/3) for yield-controlled tightening only.

Yield point scatter is +15% for 12.9 and 10.9 bolts only, and +30% for 8.8 and lower.

For 12.9 and 10.9 bolts, a factor of 1.25 would be sufficient.

Pg. 37 (R12/2): $FKQ_{erf} = FQ_{max} / (qF * \mu T_{min}) + MY_{max} / (qM * r_a * \mu T_{min})$

Number of interfaces makes no difference in clamp load.

$FKQ_{erf} = FQ_{max} / \mu T_{min}$

Rather the clamp load should be increased due to the larger distance between the radial loads, causing a bending load $FQ * distance$.

Pg. 50, 51, 52

Bending body must be calculated from the real geometry (prismatic), not from a virtual deformation body (cylinder and cone) of the bolted joint.

Pg. 67 Equation (98): $\phi_{im}^* = n * \dots$

Load introduction coefficient of axial load FA must not be used with MB.

Pg. 69 Table 4

Cit.: „distance v is always positive“

Then distance u is always positive, too. Because $u + v = cT$ (length of interface area).

How if alternating load FA? Load case I for F_{Amax}, and load case IV for F_{Amin}? With commutation of u and v for each load cycle? Why must point U always lie at the "side of the interface which is at risk of opening"?

Table 4 with sign rules is unnecessary. If bolt axis and FA lay on the same side of the center of gravity axis of the interface area, s_{sym} is positive. If bolt axis S and FA lay opposite to the gravity axis 0-0, s_{sym} is negative.

Pg.88, Figure 33

A limitation line at tensile strength (FM,Rm) would be helpful. For bolts 12.9 or 10.9, FM,Rm would be less than $1.4 * FM_{Tab}$.

Load-deformation curves in figure 33 apply for quality 8.8 or worse.

Pg. 88 (149)

Cit.: $\sigma_Z = 1/A_0 * (FM_{zul} + FS_{Amax} - \Delta FV_{th}) + MS_{bmax}/W_b$

For eccentric load, bending stress by MB has to be added. And for operating state, FM_{zul} can be replaced by FV_{max}.

Centric: $\sigma_Z = \max(FM_{zul}/A_0, 1/A_0 * (FV_{max} + FS_{Amax} - \Delta FV_{th}))$

Eccentric: $\sigma_Z = \max(FM_{zul}/A_0, 1/A_0 * (FV_{max} - \Delta FV_{th}) + \sigma_{SAb})$

Remark: FS_{Amax}/A_0 and MS_{bmax}/W_b is included in σ_{SAb} . And equation (186) has to be modified, so that external bending moments MB are considered., see Pg.95.

Pg. 88: (150):

Equation (150) is redundant, equation (149) is sufficient

Pg. 90,91: FV1

Clamp Load FV1 calculated with equation (161) is higher than permissible assembly preload FM_{zul}.

Pg. 95 (186)

Bending moment MB is not considered in Sigma Sab calculation.

And stress in the weakest area (with A0 and Wb0 instead of AS and WS) should be calculated (concerns hollow bolts and waisted bolts)

Equation (186) with bending moment FA*a and bending moment MB should be:

$$\sigma_{Sab} = \phi_{tension} \cdot F_A / A_0 + \beta_P / \beta_S \cdot (F_A \cdot a - F_A \cdot s_{sym} \cdot \phi_{tension} + MB(1 - \text{sign}(s_{sym})) \cdot \phi_{tension}) / W_{b0}$$

Pg. 96 (187, 188, 189)

Equations (187), (188), (189) are redundant.

Pg.99: Equation (201)

C1 is undefined for s/d < 1.4 and for s/d=1.9

Pg.99: Equation (202)

$$C3 = 0.728 + 1.769 RS - 2.896 RS^2 + 1.296 RS^3$$

Function has a maximum at 0.429, not at 0.4. And a minimum at RS=1.061

Scope for RS should be 0.43 .. 1

And for RS <= 0.43: C3=1.055 (not RS=0.4).

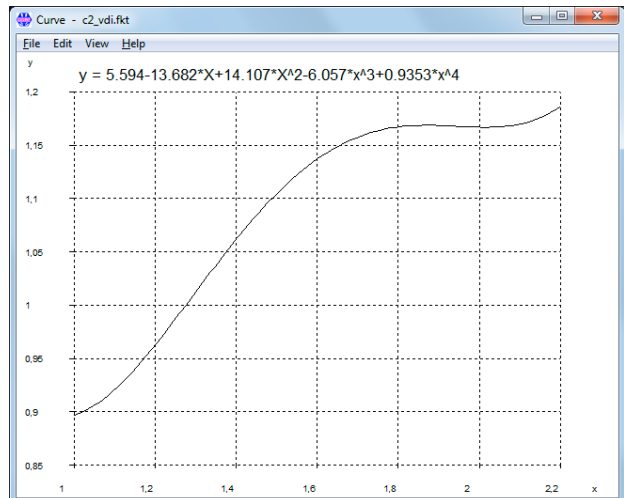
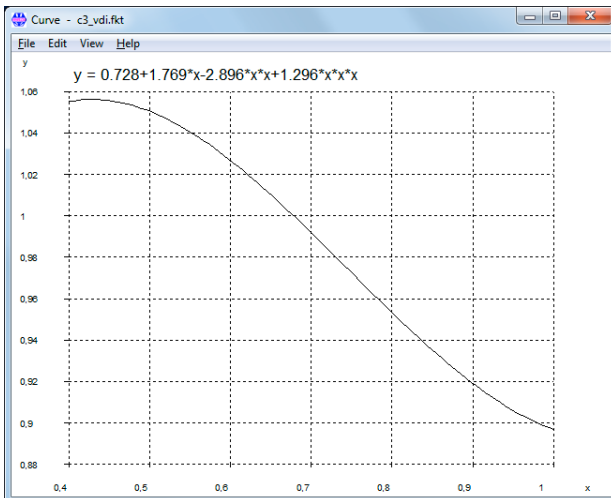

Pg. 102: Equation (211)

„RS3“ supposed to be „RS“ instead.

And the polynomial function for C2 is not continuous.

Pg. 102: Equation (213)

.. + 1,2P, is this mzu? Why is the "supplement for length of thread engagement" here 1.2 P only, and in any other case 2.0 P by default?

Pg. 103: Equation (217)

FQres = FQmax/qF + Mymax/(qM*ra) with qF = number of interfaces.

Radial load does not decrease over interfaces.

Pg. 122: Table A9:

Limiting surface pressure of **42CrMo4**: $p_G = 300 \text{ N/mm}^2$, maybe should be 1300 N/mm^2 .

16MnCr5 with $p_G = 1300 \text{ N/mm}^2$ (case-hardened?) is a case-hardening steel

GJL-250 has mat. no. 0.6025, and mat. no. 0.6020 belongs to GJL-200.

Pg. 130: Annex B Calculation Examples

Module of elasticity (E) of bolt materials 8.8, 10.9 and 12.9 is 210000 MPa at 20°C . However, in all of the calculation examples, $E = 205000 \text{ MPa}$ was used.

Pg. 132: Example B1: R2:

Minimum clamp load required is 1000 N , not 103 N .

Pg. 132: Example B1: R3:

Cit.: „Due to the relatively small differences between the diameter of the head bearing surface ($d_w = 17.23 \text{ mm}$) and the bearing surface diameter in the interface ($D_{St}=25 \text{ mm}$) ... as a simplification a mean bearing diameter surface can be used in calculation.“

Comment: The „relative small difference“ is „only“ $45 \% \quad (25-17,23)/17,23 * 100\%$.

The result of the precise calculation is $\Delta P = 0.422\text{E-}6 \text{ mm/N}$ and $\phi K = 0.178$.

Bearing diameter d_w of the piston rod should also consider the chamfer, so that d_w may be about 23 mm .

Pg.134: Example B1: R8:

Mistake: F_{Smax} is $66\ 194 \text{ N}$, and not $64\ 194 \text{ N}$.

Pg. 136: Example B1: R11:

$\tau_{BM}/R_{mM}=0.657$, $\tau_{BS}/R_{mS}=0.62$, $\rightarrow RS=0.985$.

If calculated with thread tolerances, $RS > 1$ (1.01), this means critical bolt thread.

Pg. 138: Example B2: R0:

Rough determination step D: column 3 of table A7 at $100\ 000 \text{ N}$ is not M16, but M18 for strength grade 10.9.

Pg. 143: Beispiel B3:

Drawing: Minimum bolt diameter should be d_0 . But in the drawing, minimum bolt diameter is smaller than d_0 . Or the drawing is correct, and error is in dimensioning of d_0 . I assume that d_0 is minimum external bolt diameter, and the first section of the bolt (dimensioned with d_0) is 27 mm.

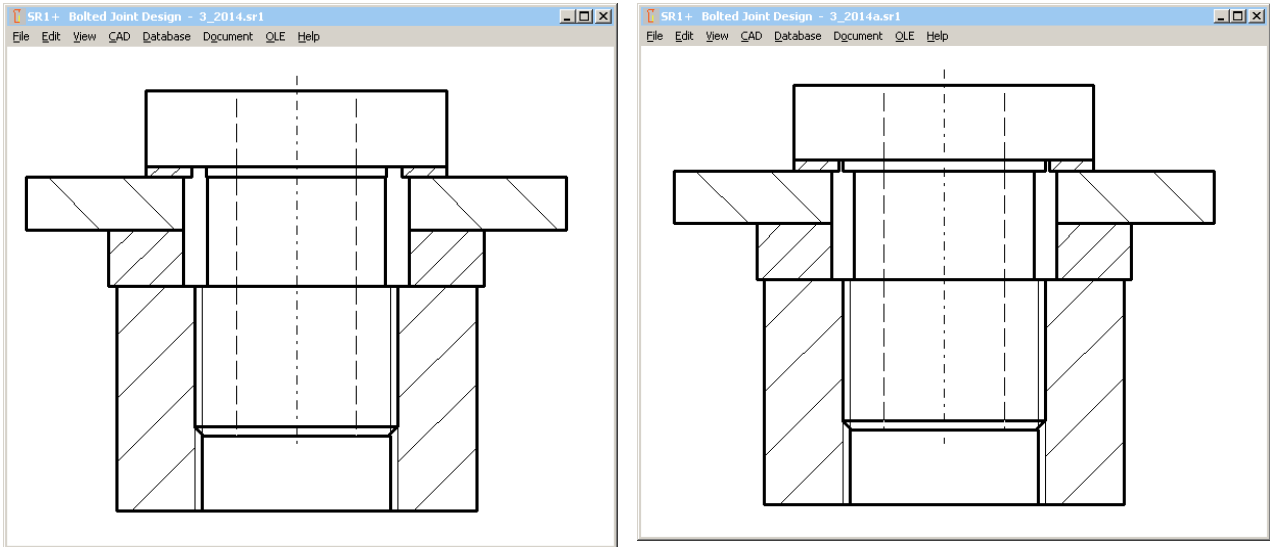

Pg.142,143: Example B3:

If bolt head $d_w=36$ mm and nut $d_w=48$ mm (relative small difference 33%), bolted joint has to be calculated as TBJ, instead of TTJ (same as example B1).

Pg.144: Example B3:

$\Delta i = (I_1 + I_2 + I_3) / ES / (A_0 - A_{\text{Bohrung}})$

A_0 wrong, because of different diameters d_1, d_2, d_3

Pg.147 Example B3: R10 Flächenpressung

$$A_p = \pi/4 * (36^2 - 29^2) = 357 \text{ mm}^2$$

$$p_{M\max} = 140300\text{N} / 357\text{mm}^2 = 393 \text{ N/mm}^2$$

$$S_p = 1.8$$

Pg.147 Example B3: R10 Pressure

False: Table A9: $p_G=900 \text{ N/mm}^2$

Right: Table A9: $p_G=1300 \text{ N/mm}^2$ for 16MnCr5

Pg.147: Example B3: R11 Length of engagement

Equation used for calculation of RS is valid for equal shear stress coefficients of bolt material and nut material only. But τ_{BS}/R_m of 8.8 is 0.65 and τ_{BM}/R_m of 16MnCr5 is 0.85 according to VDI2230-1:2014 tables. Calculated RS is then 2.0, and not 1.52.

Pg.148: Example B3: R11 Length of engagement

Cit.: „while this applies to the hollow bolt: $R_{mmax} \cdot A_S = F_{Mzul}$ “

What? $R_{mmax} \cdot A_S = F_{Mzul}$? Why?

For hollow bolts, use A_0 instead of A_S , but not F_{Mzul} .

$$R_{mmax} \cdot A_0 = 830 \text{ N/mm}^2 \cdot 1.2 \cdot 251 \text{ mm}^2 = 250 \text{ kN}$$

That is approx. twice as F_{Mzul} .

Calculated length of engagement is then 4.85 mm only, plus $m_{zu}=2.4\text{mm}$

Here the correct results:

$m_{effmin} = 8,0\text{mm}$ (instead of 4,8mm) with $R_{mmax} \cdot A_0=250\text{Nm}$ and $C_2=1.16$ from $RS=2.0$

$$m_{gesmin} = m_{effmin} + m_{zu} = 8 + 1.2 \cdot 2 = 10.4 \text{ mm}$$

Why is m_{zu} 1.2 P only? Normally, it is 2.0 P.

Pg. 149: Example B4:

Faulty design: fitting surface of the bolt does not meet interface between connecting rod and connecting rod bearing cap. Bolt must be assembled upside down (bolt head at connecting rod side) or bolt dimensions have to be modified.

Apart from that, I would recommend a fine thread for this application.

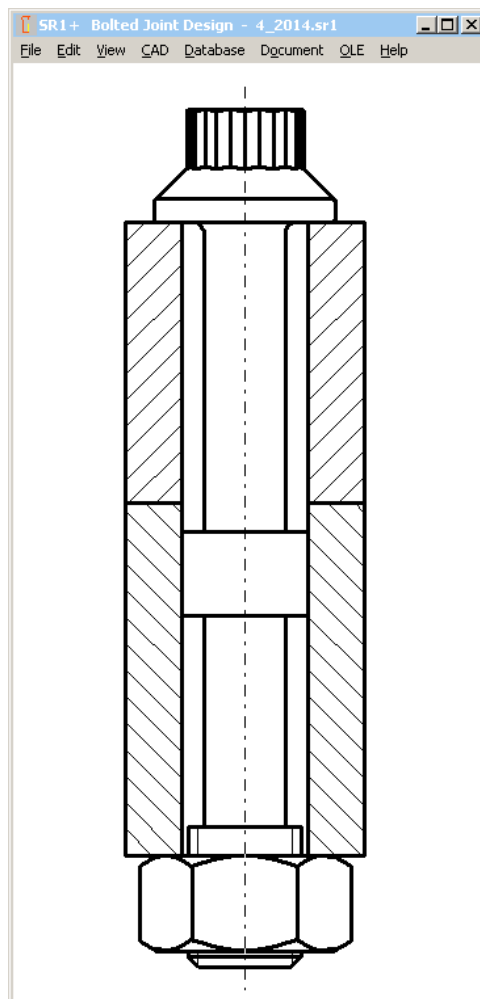

Pg.149: Example B4: Initial conditions

Cit: “Cq 45 heat treated to a tensile strength of 900 N/mm^2 “

Cq45 cannot be heat-treated to 900 N/mm^2 . +QT: $700-850 \text{ N/mm}^2$ for $t < 8\text{mm}$

Pg.150: Example B4: R1: Determining the tightening factor alphaA

Cit.: The bolt is tightened using the angle-controlled tightening technique.

Wrong: According to table A8, the tightening factor alphaA=1.

Right: According to table A8, the tightening factor alphaA is between 1.2 and 1.4.

alphaA=1 is a theoretical ideal case without scatter nor friction tolerance.

Pg. 152: Example B4: R2

The determination of the of the total area produces $A_{ges} = 12 \cdot 25 = 300 \text{ mm}^2$, not 272 mm^2 .

Or was it calculated with the precise interface section? If yes, these values also should be used for IBT.

But $IBT = b \cdot cT^3 = 3600 \text{ mm}^4$

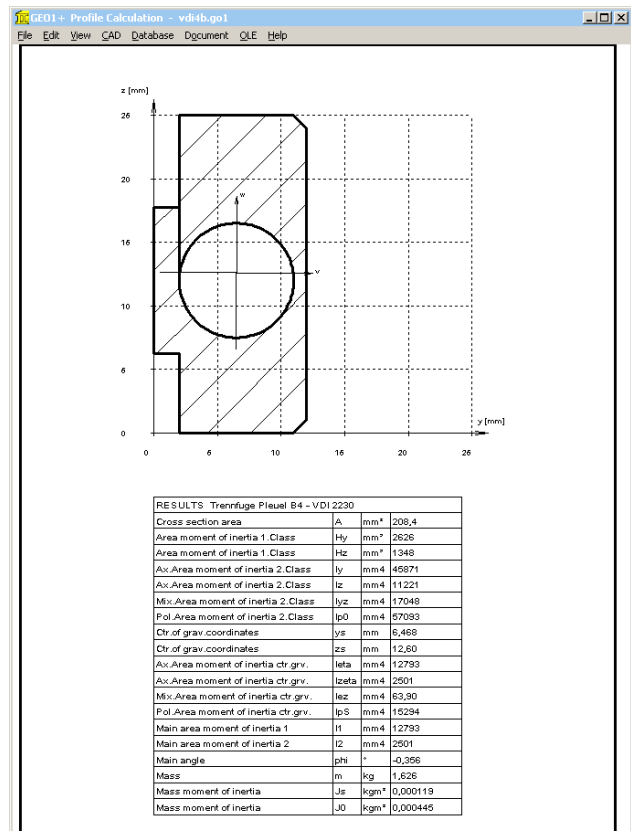
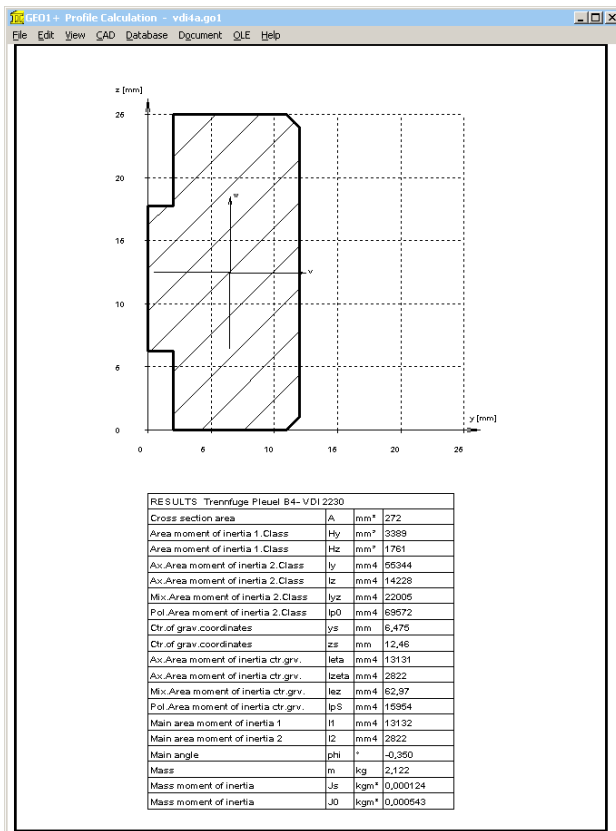

Calculated by means of GEO1+ with $A_{ges}=272 \text{ mm}^2$: $IBT = 2822 \text{ mm}^4$

Pg. 153: Example B4: R3: Elastic resilience deltaP

Bearing diameter of bolt and nut is different (12.3 mm and 11.6 mm), therefore the deformation cones are different.

$\delta P = 1.407E-6 \text{ mm/N}$

Pg. 153: Example B4: Bending body

Area moment of inertia IBers is calculated from a prismatic bending body (correct) jointed with the conical cones of the bolted joint deformation zone (false). Vice versa, cross section of the bending body has its minimum in the interface, and even increases in direction towards bolt head and nut.

Pg.155: Example B 4, R8:

Cit.: „For the preload following ... with equation (178)

Correct: .. with equation (163) ..

Pg.155: Example B4: R8:

$FV1 = 31\,467\text{ N}$

Then the clamp load following initial loading is higher than permissible assembly clamp load $FMzul$ with $26\,444\text{ N}$!

Pg.156: Example B4: R8:

Cit.: The BJ satisfies the requirements.

But working stress $\sigma_{red,B}$ should be calculated in R8, and not the remaining clamp load!

$\sigma_0 = FMzul/A_0 + \sigma_{Sabmax} = 26442 / 26.6 + 61 = 1055\text{ N/mm}^2$

$\tau_{max} = MG/W_p = 363\text{ N/mm}^2$

$\sigma_{red,B} = 1102\text{ N/mm}^2$ (with $k_{\tau}=0.5$)

$SF = R_{p0.2} / \sigma_{red,B} = 1100 / 1102 = 0.998$

Pg. 157: Example B4: R9:

σ_{SAbo} : For maximum bending stress in the weakest cross-section, $d_S = 6.827\text{ mm}$ must be replaced by $d_T = 5.82\text{ mm}$, and A_S must be replaced with $A_0 = \pi/4 \cdot d_T^2$.

σ_{SAbo} is then 62 N/mm^2

Pg. 157/158: Example B4: R10:

Concerning factor 1.4 for p_{max} , see remark pg. 37

Concerning limiting surface pressure of Cq45, see remark pg. 149

Pg. 161: Example B5: R2:

Cit.: The material region until the cylinder center is to be considered..

Thus: $D'A, I = 2 \cdot r_s = DST = 175\text{ mm}$

Comment: deformation of bolted joint is not influenced by material zone in cylinder center.

Distance to external diameter is 17.5 mm , and to the next bolt hole 14.65 mm . Thus, „ $D'A, I$ “ may be about 40 mm .

Pg. 162: Example B5:

Recalculation: $ssym$ is $+1.98$ mm, and not -1.7 mm. Even in figure B7, $ssym$ is positive. "Check for the sign rule according to table 4" corresponds to case I, and not to case III. $ssym$ is the distance between center of gravity axis and bolt axis. GEO1+ software may be used to calculate center of gravity and $ssym$.

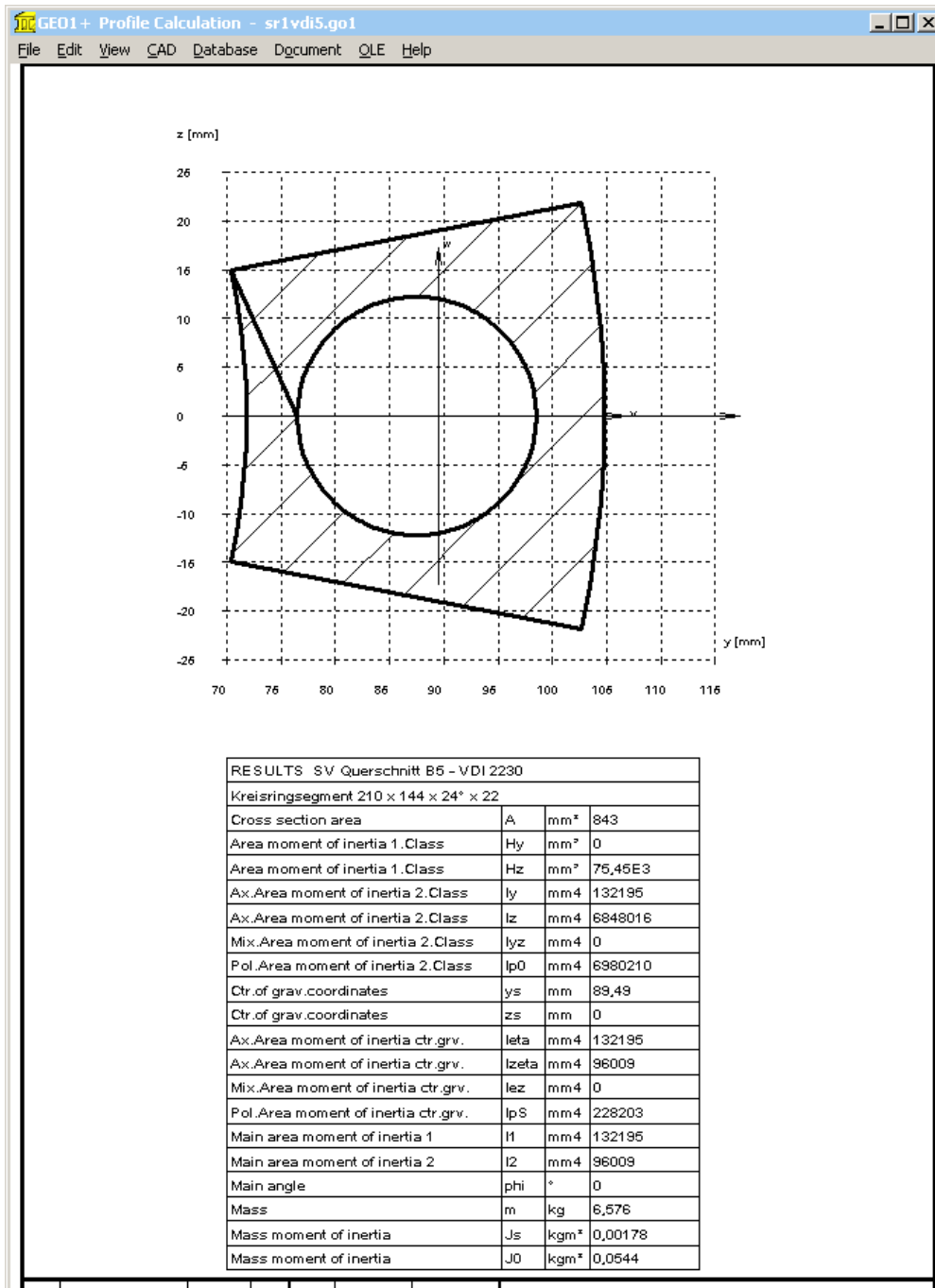

With coordinates of interface area are $r_i=72$ mm, $r_e=105$ mm, $\alpha = 24^\circ$, $r_s=87.5$ mm and $dh=22$ mm, GEO1+ calculates $y_s=89.48$ mm. Thus $ssym = y_s - r_s = 89.48 - 87.5 = 1.98$ mm, $u = y_s - r_i = 89.48 - 72 = 17.48$ mm, and $v = r_e - y_s = 15.48$ mm. Area moment of inertia at w axis is $Izeta = IBT = 95985$ mm⁴.

Pg. 163

R3: δM is not $0.104E-6$, but $0.102E-6$ mm/N

Pg. 164

lers = $5,93E-8 * 205000 * \pi / 64 * 16.93^4$ is 49.0, not 48.7 mm

Pg. 168: R8

Cit.: $\sigma_{zmax} = FS_{max} / AS = 780.3$ N/mm²

Comment: Bending stress by eccentric load not considered

Correct: $\sigma_{zmax} = FM_{zul} / A_s + \sigma_{Sab} = 190000 / 245 + 35,6 = 811$ N/mm²

$\sigma_{red,B} = 841$ N/mm²

SF = 1,12

Comment: Calculation with FV_{max} instead of FM_{zul} results in $\sigma_{zmax} = 786$ N/mm²

Pg. 170: Example B5: R11:

RS must be calculated with τ_M / τ_S instead of R_{mM} / R_{mS} , because $\tau_{BM} / R_{mM} = 0.8$ and $\tau_{BS} / R_{mS} = 0.62$ are different. RS=0.79 is correct

Pg. 170: Example B5: R11:

Insufficient length of engagement: hexagon socket head bolt M20x60 allows chamfer and non-bearing thread on a length of $u \leq 2P$ according to EN ISO 4762:2004. Together with $1 * P$ for the inner thread, length supplement to the length of engagement is then " m_{zu} " = $3 * P$. With $m_{effvorh} = m_{vorh} - 3 * P = 17,5$ mm follows that: $m_{effvorh} < m_{eff}$.

This means that a detailed calculation as per section 5.5.5 is required.

The calculated value for nominal diameter of d, D, D2 and d2: $m_{eff} = 18.2$ mm. Results with thread allowance of internal thread and bolt:

6H/6h: $m_{effmin} = 18.6$ mm

6H/6g: $m_{effmin} = 18.9$ mm

6H/6e: $m_{effmin} = 19.2$ mm

And $m_{effvorh}$ and $m_{vorheff}$ means the same in R11 of B5 ?

What is missing in VDI 2230-1:2014 ?

A table of bolt materials with E module, yield point, tensile strength, tolerance of yield point and tensile strength, shear strength and temperature coefficients, elongation after fracture.